

SRC *Plus*

Residential/Light Commercial Irrigation Controller

Owner's Manual and Programming Instructions

- **600i** 6-station Indoor Model
- **601i** 6-station Indoor Model
(International)
- **900i** 9-station Indoor Model
- **901i** 9-station Indoor Model
(International)

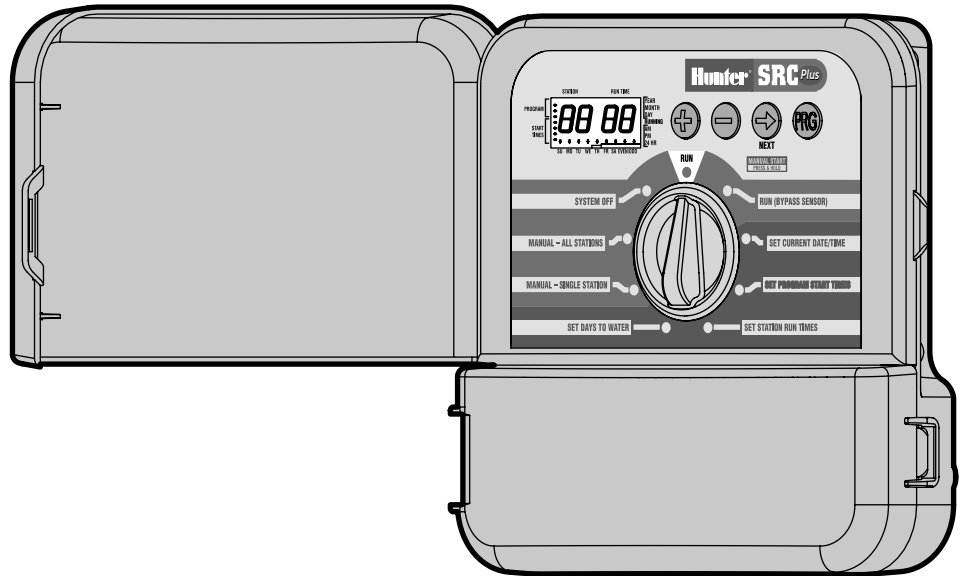

Hunter®

TABLE OF CONTENTS

INTRODUCTION AND INSTALLATION

Introduction	1
SRC <i>Plus</i> Components	2-3
Mounting Controller to Wall	4
Connecting Valves and Transformer	5
Connecting the Battery	6
Connecting a Master Valve	6
Connecting a Pump Start Relay	7
Connecting a Weather Sensor	8
Weather Sensor Bypass	8
Connecting a SRR or ICR Remote Control	9
Connecting to IMMS™ Central Control System	10
Power Failures	10

CONTROLLER PROGRAMMING AND OPERATION

Sprinkler System Fundamentals	11
Creating a Watering Schedule	12
How to Fill Out the Watering Schedule Form	12
Watering Schedule Form (Example)	13
Watering Schedule Form	14
Programming Fundamentals	15
Programming Fundamentals (Example)	16

TABLE OF CONTENTS (continued).....

Programming the Controller.....	17
Setting the Date and Time.....	18
Setting Program Start Times.....	18
Eliminating a Program Start Time.....	19
Setting Station Run Times (Length of Watering for Each Area).....	19
Setting Days To Water.....	20
Selecting Specific Days of the Week to Water.....	20
Selecting Odd or Even Days.....	20
Run.....	20
System Off.....	21
Manually Run a Single Station.....	21
Manually Run All Stations.....	21
One Touch Manual Start and Advance.....	22
Hunter Quick Check™.....	22
Clearing Controller's Memory / Resetting the Controller.....	22

TROUBLESHOOTING AND SPECIFICATIONS

Troubleshooting Guide.....	23-24
Specifications.....	25
FCC Notice.....	Back Cover

INTRODUCTION

Finally, there's an affordable controller for your home.

Hunter Industries is pleased to present the SRC *Plus* – a Simple and Reliable Controller for residential applications. Designed with the needs of the customer in mind, the SRC *Plus* offers simplified dial programming and an impressive range of features typically found in controllers costing twice as much.

While it's affordable, the SRC *Plus* is without a doubt a professional grade product. The controller's large, handsome cabinet, complete with a protective door, provides your controller with a neat and professional appearance. And, the SRC *Plus* is filled with the essential features that landscapers demand (like a rain sensor bypass circuit and primary power surge protection), but without some of the unnecessary frills that often lead to contractor call back.

The SRC *Plus* is so easy to use that after reading this User Guide thoroughly, you will need it very little after installation. We have also included an abbreviated instruction sheet inside the door of the controller for quick reference later on. After a few uses of this controller, you can be sure the SRC *Plus* is a product that does the job efficiently and economically.

The SRC *Plus* is an improved version of the original SRC *Plus*. Additional features and improvements include:

- Non-volatile memory
- More robust circuitry
- One touch manual start and advance
- Hunter Quick Check™
- Automatic Short Circuit Protection

SRC PLUS COMPONENTS

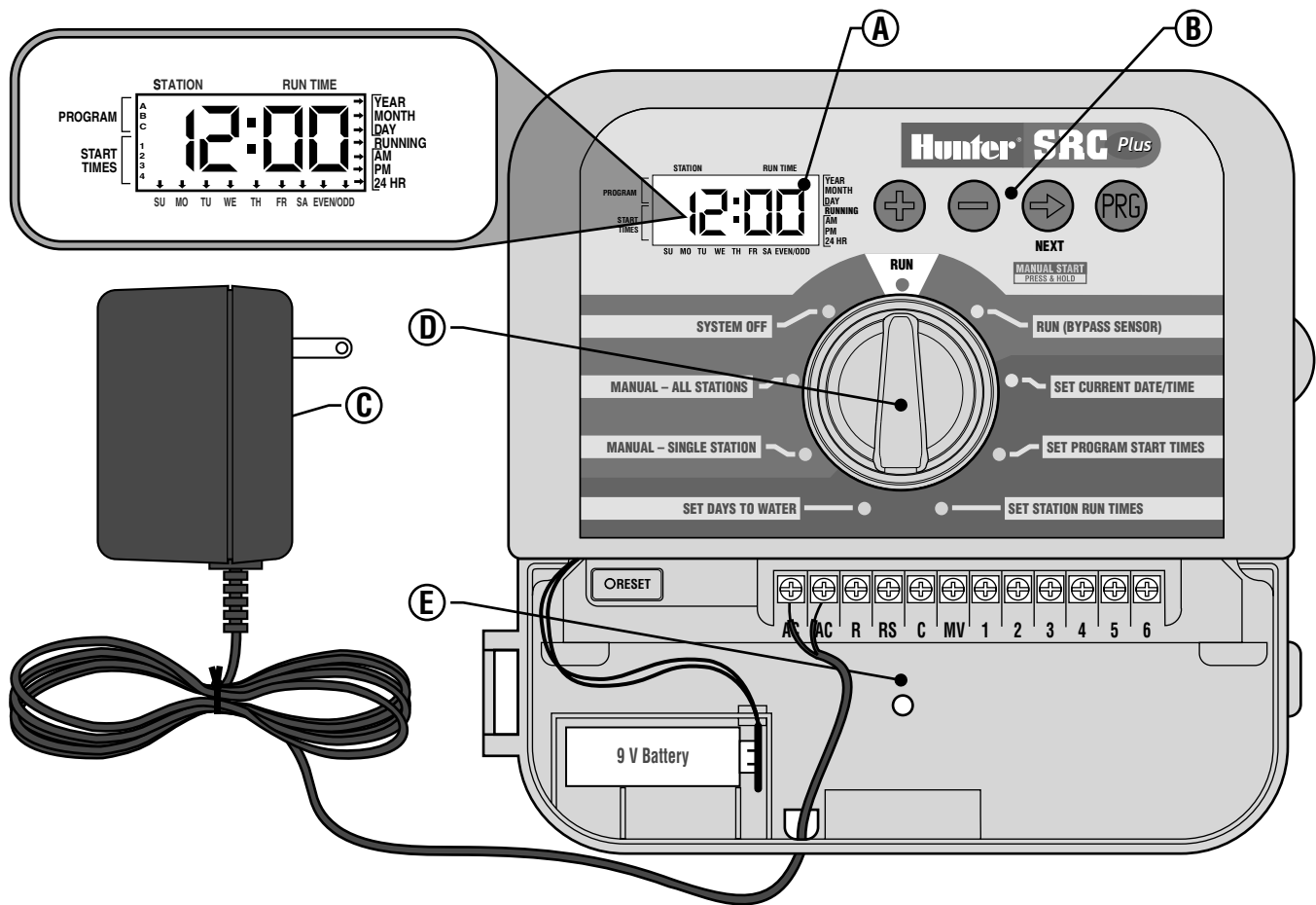

This section will give you a brief overview of some of the components on the SRC *Plus* faceplate. Each item will be discussed in further detail later, however this section can be helpful in getting acquainted with the different options available.

A – LCD Display

Start Time – Identifies selected start time (only one start time per program is required).

Program Designator – Identifies program in use A, B, or C.

Station Number – Identifies currently selected station number.

LCD Display – Indicates various times and values.

Run Time – Duration of individual stations watering.

Year – Current calendar year.

Month – Current calendar month.

Day – Current calendar day.

Running – Indicates when watering is occurring.

AM/PM – Arrow differentiates either AM or PM time.

24 HR – 24-hour time is available in addition to AM and PM.

Day of the Week – Identifies days of the week to water or you can select to water on odd or even days.

(For all above LCD display items, when an arrow cursor is flashing, that is what you are setting.)

B – Control Buttons

+ **Button** – Increases the selected flashing display.

- **Button** – Decreases the selected flashing display.

→ **Button** – Advances the selected flashing display.

PRG **Button** – Selects program A, B, or C.

C – Transformer

A 120 VAC Plug-in transformer (included in SRC -600i and 900i models) supplies 24 VAC to the controller.

D – Control Dial

A key feature of the SRC *Plus* is its clear, easy-to-use dial design that makes programming a snap. All essential keypad functions are clearly marked to eliminate the confusion that's a characteristic of so many other controllers.

Run – Normal dial position for automatic and manual operation.

Run (Bypass Sensor) – Used to disengage optional weather sensor that may be wired to your system.

Set Current Date/Time – Allows current date and clock time to be set.

Set Program Start Times – Allows 1 to 4 start times to be enabled in each program.

Set Station Run Times – Allows user to set each station run time from 0 to 99 minutes.

Set Days To Water – Allows user to select individual days to water or to select an odd or even watering schedule, according to the date.

Manual – Single Station – Allows user to activate a one time watering of a single station.

Manual – All Station – Allows user to activate a one time watering of all stations or a few selected stations.

System Off – Allows user to discontinue all programs and stop all watering until dial is returned to the **RUN** position.

E – Wiring Compartment

Reset Button – This button will reset the controller. All programmed data will remain intact.

9-Volt Battery – The alkaline battery will maintain the controller memory if power to the transformer is disconnected. However, the battery will not operate any of the watering activity (not included).

Transformer – The two wires from the plug-in transformer are connected to the two AC terminals.

Terminal Strip Area – Use to attach transformer and valve wires from their source to the controller.

MOUNTING CONTROLLER TO WALL.....



NOTE: The SRC *Plus* is not water or weather resistant. The controller must be installed indoors or in a protected area.

1. Select a location as close as possible to a standard electrical outlet, one that is not controlled by a light switch. The location should be protected from moisture and direct sunlight.
2. Remove the mounting bracket (A) from the back of the controller housing by pulling the bracket down and slightly away from the unit.
3. Place the mounting bracket slightly below eye level. Using the hole at the top and the slide cutout at the bottom, secure the bracket with the 1" (25mm) screws (B) provided. **Note: Install screw anchors if attaching mounting bracket to drywall or masonry.**
4. Align slotted openings on back of controller housing (C) with rails on the mounting bracket (D). Gently slide the controller down into position on the bracket.
5. Secure controller in place by installing a screw through the lower central mounting hole.

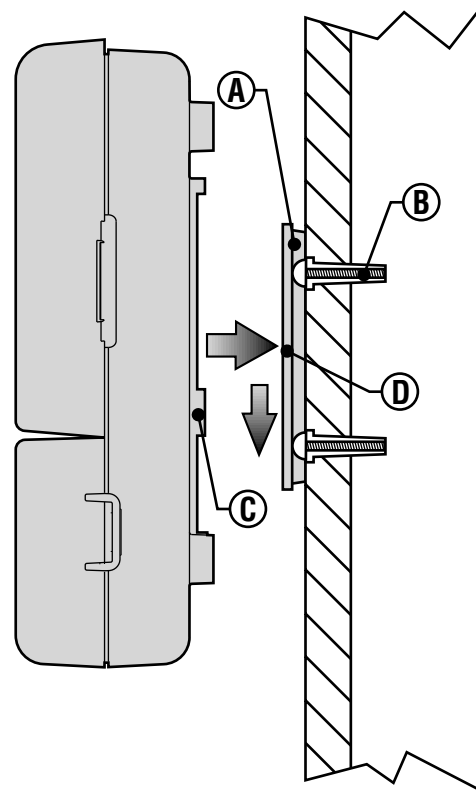

CONNECTING VALVES AND TRANSFORMER

1. Route control wires between control valve location and controller. Typically it is recommended that an 18 AWG multi-wire sprinkler connection cable be used. This type of connection is insulated for burial and is color-coded to help keep track of your connections.
2. At the valves, attach the common wire to either solenoid wire of the valve. This is most commonly the white colored wire. Attach a separate control wire to the remaining solenoid wire and make a note of the color corresponding to each valve and the watering station it controls.
3. Secure the wires with a waterproof wire connector to protect the connection.
4. Open hinged wiring compartment door to access the terminal strip area shown in the diagram.
5. Route the valve wires through the large opening on the base of the cabinet or through ½ inch conduit if installed. Strip ¼ inch of insulation from ends of all wires.
6. Secure the white valve common wire to the screw on the terminal marked **C**. With the valve common wire connected, connect the color-coded wires from the valves to their appropriate station numbers and tighten the screws.
7. Route transformer cable through the small hole in the bottom of the cabinet and connect the wires to the two screws marked **AC**.

 **NOTE: Do not plug transformer into power source until the controller is mounted and all valves have been connected.**

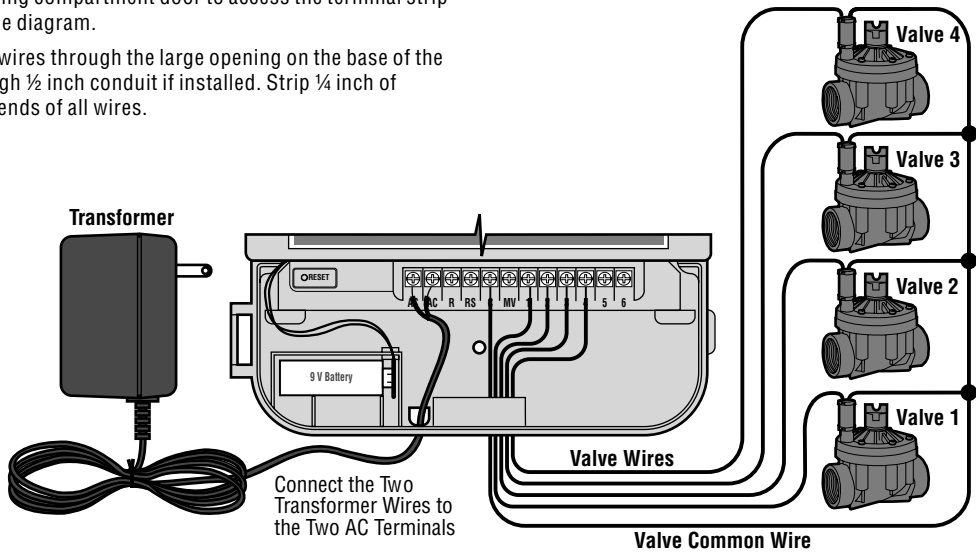

CONNECTING THE BATTERY.....

The battery allows you to program the SRC *Plus* Controller without having AC power available. However, **the battery will not be able to activate any of the station valves**. Electrical power must resume before watering will continue. The SRC *Plus* has non-volatile memory which retains all program information in the event of a power outage.

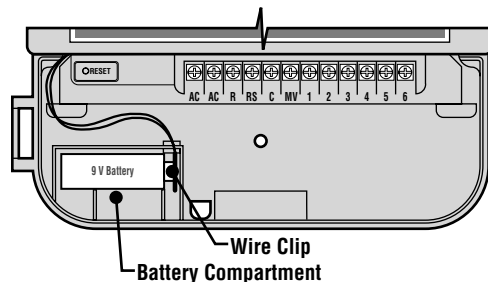

CONNECTING A MASTER VALVE.....



NOTE: Complete this section only if you have a master valve installed. A master valve is a normally closed valve installed at the supply point of the main line that opens only when the automatic system is activated.

1. At the Master Valve, attach the common wire to either solenoid wire of the valve. Attach a separate control wire to the remaining solenoid wire and make a note of the color corresponding to the master valve.
2. Route these wires to the controller the same way as the station valves. The white common wire will still go to the screw slot marked **C**. The additional wire coming from the master valve will go in the screw slot marked **MV**.

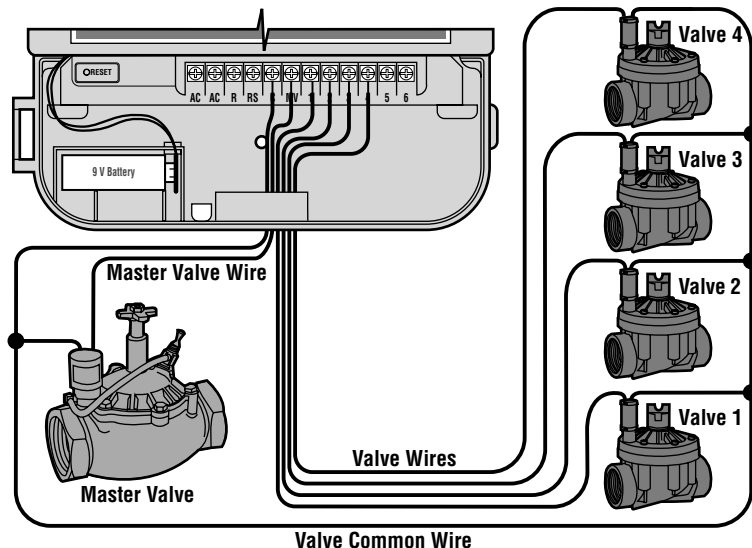

CONNECTING A PUMP START RELAY.....



NOTE: Complete this section only if you have a pump start relay installed. A pump start relay is an electronic device that uses a current from the controller to actuate a separate electrical circuit to energize a pump to provide water to your system.

The controller should be mounted at least 15 feet (4.5m) away from both the pump start relay and the pump. When a pump start relay comes on it sends out surges that may potentially cause damage to a controller that is mounted to close. When a pump is to be operated by the controller, a pump start relay must be used. Hunter offers a full range of pump start relays for most applications.

1. Route a wire pair from the pump relay into the controller housing.
2. Connect common wire to the screw slot **C** (Common) and the remaining wire from the pump relay to the **MV** screw slot.

Relay current draw must not exceed .35 Amps. **Do not connect controller directly to pump – damage to controller can result.**

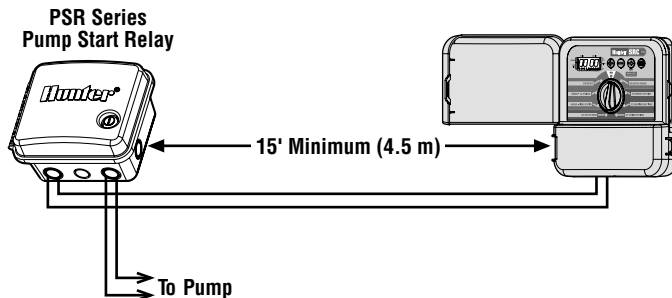

NOTE: If a rain sensor is installed with your SRC *Plus*, along with a pump start relay, follow instructions on page 8.

CONNECTING A WEATHER SENSOR

A Hunter Mini-Clik® rain sensor can be connected to the SRC *Plus*. The purpose of this sensor is to stop watering when precipitation is sufficient. The sensor connects directly to the controller and allows you to easily override the sensor by using the **RUN (BYPASS SENSOR)** position on the dial.

1. Route the wires from the rain sensor up through the same opening used for valve wiring.
2. Connect one rain sensor wire to the **RS** terminal and the other to the **C** terminal.
3. Connect the valve common from the field to the **RS** terminal.

Note: If a pump relay is being used, the pump relay common must also be connected to the **RS** terminal.

A weather sensor shuts off your system during rainy weather – saving water. Ask your installer for more information on this device.

Weather Sensor Bypass

With this built-in feature, there is no need for an additional manual bypass switch when using rain sensors. The SRC *Plus* works with the Hunter Mini-Clik®, Rain-Clik™, Freeze-Clik® plus some other rain, wind or freeze sensors on the market today. If the sensor is preventing system operation, just turn the dial to **RUN (BYPASS SENSOR)** and the weather sensor will be overridden.

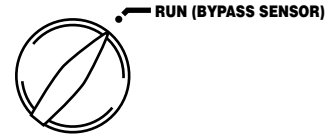

Hunter Weather Sensor

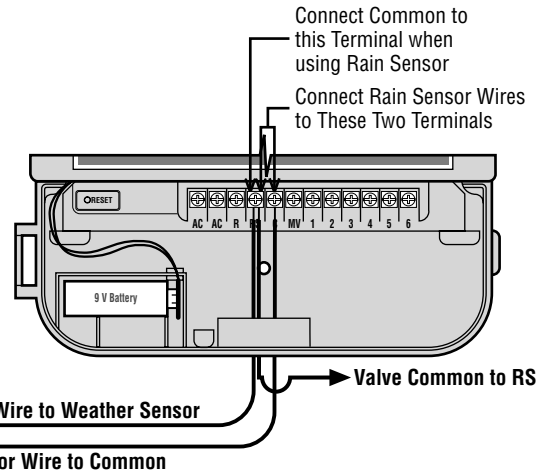
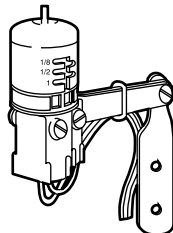

CONNECTING A SRR OR ICR REMOTE CONTROL (not included)

The Hunter SRC *Plus* is remote-ready for use with the SRR or ICR remote control system. The remote makes it possible for contractors and end-users alike to operate an system without having to walk back and forth to the controller.

To utilize the SRR or ICR Remote Control System you must install the SmartPort® outlet.

1. Install a ½" female threaded PVC "Tee" in the field wiring conduit (PVC pipe) approximately 12" below the SRC *Plus*.
2. Feed the red, white, and blue wires of the harness through the base of the "Tee" and into the wiring compartment as shown in Figure 1.
3. Screw the harness housing into the "Tee" as shown in Figure 1.
4. Access the terminal strip area and attach the red wire to the left **AC** screw slot, attach the white wire to the next **AC** screw slot and attach the blue wire to the screw slot marked "R".

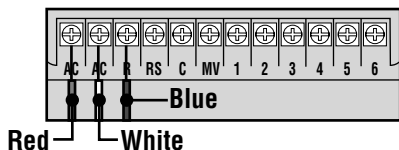
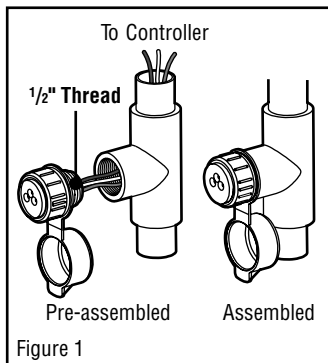

The wiring harness is now ready for remote control use. Please refer to the SRR or ICR owner manual for further information or contact your local Hunter distributor for ordering information.



NOTE: Any extension of the wiring on the remote harness may result in an error message in the controller display and possible malfunction of the remote unit due to radio interference. In some situations, lengthening of the harness may work fine, in others it may not work at all (it is site specific). In either case, extending the wiring harness should be done using shielded cable to minimize the possible effects of electrical noise. For easiest installation, order a new Hunter SRR-SCWH SmartPort® wiring harness with a full 25 feet of shielded cable.

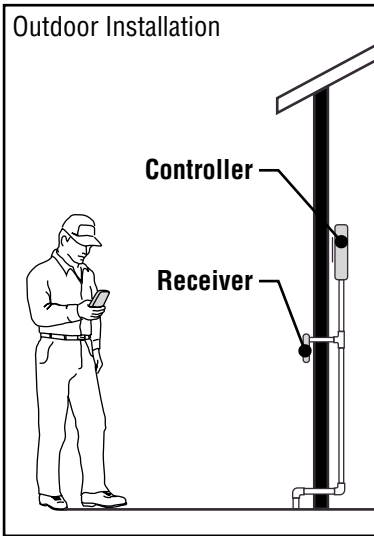
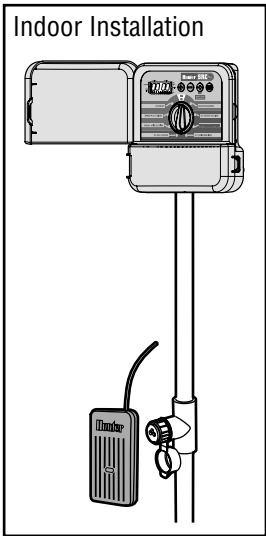

CONNECTING TO THE HUNTER IRRIGATION MANAGEMENT AND MONITORING SYSTEM™ (not included)

With the IMMS™, automatic irrigation systems at multiple sites or multiple controllers at a single site can be programmed for functions that would typically be handled directly at each controller. Scheduling of days to water, run times, start times, cycle and soak operations, and more can now be done from a single computer at a desk miles away from the actual installation. In addition, scheduled operation of non-irrigation components also in use at these sites—e.g., lighting systems at athletic fields, fountains at shopping centers—as well as pumps and sensors can also be programmed and monitored from a single central location. A key function of the IMMS is its ability to

monitor changing conditions. With the aid of such options as flow sensors, rain sensors and other weather-sensing devices, the IMMS can receive reports on the current condition at every site it is linked with and then respond with the necessary adjustments should any of those conditions go beyond the limits that have been defined. It's able to team with any or all of the standard automatic controllers in the Hunter line-up, from the SRC *Plus* to the Pro-C to the ICC. Plus, it's a system that's easy and affordable to upgrade, making it possible to accommodate an expanding network of controllers. For more information on the IMMS software, contact your local Hunter dealer.

POWER FAILURES

Due to the possibility of power failures, the controller has non-volatile memory to preserve the program indefinitely. If no 9-volt battery is installed, the controller will freeze time when the power goes out and resume, keeping time after power has been restored. If a battery is installed, the 9-volt battery backup will keep time so the clock and calendar will be intact for several days.

SPRINKLER SYSTEM FUNDAMENTALS.....

There are three main components that are involved with all automatic sprinkler systems that are made today. They are the **controller**, **valves**, and the **sprinklers**.

The controller is what makes the whole system operate efficiently. It is technically the brain of the entire system, instructing the valves when to supply water to the sprinklers and for how long to do so. The sprinklers, in turn, will direct the water towards the surrounding plants and lawn.

The valve controls a group of sprinklers called a watering **station**. These stations are laid out in a fashion according to the type of plant life that exists there, the locations of the plants, and the maximum amount of

water that can be pumped to the location. Each valve is connected via wire to the terminal strip area inside of the controller. Here the wire is connected to a number that corresponds to the valve's station number.

The controller will operate the valves in order, only one at a time. When a valve has completed its watering; it will switch to the next station that has been programmed. This process is called the watering cycle. The information pertaining to the watering times of the individual stations and how often watering occurs is called a **program**.



- Valve 1** – Activates Station 1 – Rotors water front yard lawn
- Valve 2** – Activates Station 2 – Sprays water side lawn and bubblers water flowers
- Valve 3** – Activates Station 3 – Rotors water back yard lawn
- Valve 4** – Activates Station 4 – Bubblers water garden
- Valve 5** – Activates Station 5 – Sprays water side lawn and bubblers water flowers
- Valve 6** – Activates Station 6 – Sprays water front corner lawn

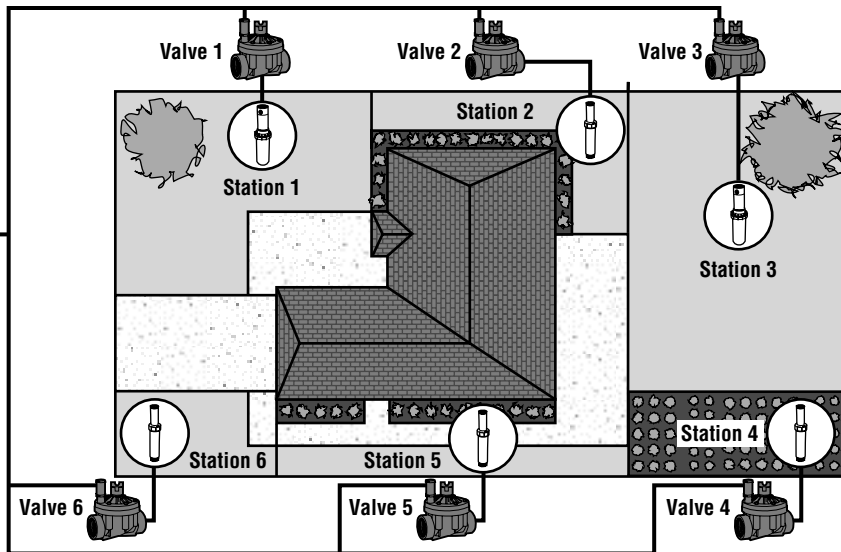

CREATING A WATERING SCHEDULE.....

For most consumers, it is much easier to plan your specific watering schedule onto paper before actually programming the information into the controller. It's also handy to have a written record of your programming information for easy reference.

There are some guidelines that should be followed when determining when and how long to water. These factors are the soil type, the part of the landscape being watered, weather conditions, and the types of sprinklers being used. Since there are so many different variables that can determine your individual watering schedule, it is impossible to give an exact schedule to follow. However, we have included some guidelines to help you get started.



NOTE: It is usually good to water one or two hours before sunrise. Water pressure will be at optimum levels during the early morning and the water can soak into the roots of the plants while evaporation is minimal. For most plants, watering during midday or in the evening may cause plant damage or possibly mildew.



NOTE: Keep an eye out for evidence of under- or over-watering. Over-watering is most commonly indicated by pools of water that take a long time to soak in or evaporate, while under-watered landscapes will show signs of discoloring and dryness. Make programming changes immediately when evidence is present.

HOW TO FILL OUT THE WATERING SCHEDULE FORM.....

Be sure to use a pencil when filling out this form. By using the included example and the information below, you should have all the information you need to construct your personal water schedule.

Station Number and Location – Identify the station number, location and the type of plant that is being watered.

Watering Day – Identify whether you want to use a calendar day or an odd or even day schedule. For a calendar day schedule circle the day of the week in which watering is desired. For a odd or even day schedule, simply mark the corresponding box.

Program Start Times – Indicate the time of day that the program will begin. Each program can have 1 to 4 start times. However, one start time can run an entire program.

Station Run Time – Indicate the run time (1 to 99 minutes) for each station. Write “OFF” for any station that you do not want to operate in the program.

Keep this schedule in a safe place for quick reference later, rather than scrolling through program information on the controller.

WATERING SCHEDULE FORM EXAMPLE

		PROGRAM A							PROGRAM B							PROGRAM C							
WATERING DAY SCHEDULE	CALENDAR	SU	MO	TU	WE	TH	FR	SA	SU	MO	TU	WE	TH	FR	SA	SU	MO	TU	WE	TH	FR	SA	
									X	X	X	X	X	X	X								
	ODD/EVEN	ODD <input checked="" type="checkbox"/>				EVEN <input type="checkbox"/>			ODD <input type="checkbox"/>				EVEN <input type="checkbox"/>			ODD <input type="checkbox"/>				EVEN <input checked="" type="checkbox"/>			
STATION	LOCATION	ZONE RUN TIME							ZONE RUN TIME							ZONE RUN TIME							
1	Front Lawn	00:15							00:00							00:00							
2	Side Lawn	00:15							00:00							00:00							
3	Back Lawn	00:20							00:00							00:00							
4	Flowers	00:00							00:15							00:00							
5	Garden	00:00							00:00							00:20							
6	Front Corner	00:00							00:00							01:00							
7																							
8																							
9																							
PROGRAM START TIMES		1	6:00 AM							8:00 AM							5:00 AM						
		2	Off							Off							Off						
		3	Off							Off							Off						
		4	Off							Off							Off						

WATERING SCHEDULE FORM.....

		PROGRAM A							PROGRAM B							PROGRAM C							
WATERING DAY SCHEDULE	CALENDAR	SU	MO	TU	WE	TH	FR	SA	SU	MO	TU	WE	TH	FR	SA	SU	MO	TU	WE	TH	FR	SA	
	ODD/EVEN	ODD <input type="checkbox"/>				EVEN <input type="checkbox"/>			ODD <input type="checkbox"/>				EVEN <input type="checkbox"/>			ODD <input type="checkbox"/>				EVEN <input type="checkbox"/>			
STATION	LOCATION	ZONE RUN TIME							ZONE RUN TIME							ZONE RUN TIME							
1																							
2																							
3																							
4																							
5																							
6																							
7																							
8																							
9																							
PROGRAM START TIMES		1																					
		2																					
		3																					
		4																					

PROGRAMMING FUNDAMENTALS

A watering program can be created to operate valves in numerical sequence one at a time. All that is required to create a watering program is to:

1. Select a program (**A**, **B**, or **C**) by pressing the  button on the controller (it is recommended to start with **Program A**).
2. Set a program start time (only one program start time is required to activate a watering program).
3. Set the run time for each valve assigned to the program, and
4. Set the days that you would like the watering program to run.

We have included an example that will better illustrate the operation of a program:

Let's say you have a program start time set for 6:00 AM. Stations 1 and 2 are going to have a run time of 15 minutes and station 3 is set for 20 minutes. Please note that stations 4, 5 and 6 have not been included in this program, we will water them on separate programs.

Going back to our previous example, at 6:00 AM the controller will activate the watering cycle. The sprinklers on station 1 will run for 15 minutes and then automatically shut off. The controller will automatically advance to station 2 sprinklers. These sprinklers will also run for 15 minutes and then shut off. Then, watering on station 3 will begin automatically. The sprinklers will turn on for 20 minutes and shut off automatically. Since no times were programmed for stations 4, 5 and 6, the controller skips them. This will conclude the program and end the water cycle at 6:50 AM.

As shown in the above example, **only one program start time** was required to run the three different stations. The controller automatically moves to the next station without the need for additional start times.

We realize that many consumers will have variations in their plant watering needs, so at Hunter we equipped the SRC *Plus* with three different programs A, B, and C. These programs are completely independent of each other and give you the ability to have three coexisting timers in one controller.

PROGRAMMING FUNDAMENTALS EXAMPLE

WATERING DAY SCHEDULE		CALENDAR	PROGRAM A						
			SU	MO	TU	WE	TH	FR	SA
		ODD/EVEN	ODD <input checked="" type="checkbox"/>			EVEN <input type="checkbox"/>			
STATION	LOCATION	ZONE RUN TIME							
1	Front Lawn	15 minutes							
2	Shrub	15 minutes							
3	Side Yard	20 minutes							
4									
5									
6									
7									
8									
9									
PROGRAM START TIMES		1	6:00 AM						
		2							
		3							
		4							

Total Cycle of Program A = 50 minutes

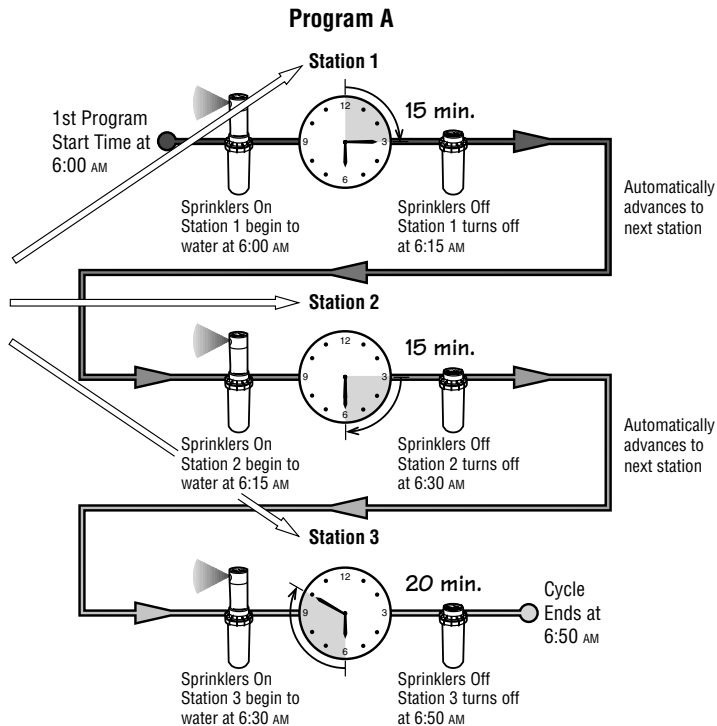

PROGRAMMING THE CONTROLLER

The SRC *Plus* Controller is simple to program. The easy to understand dial design allows you to step through the process of programming and activate manual watering with a twist of the dial.

The SRC *Plus* display shows time and day when the controller is idle. The display changes when the dial is rotated to indicate the specific programming information to enter. When programming, the flashing portion of the display can be changed by pressing the **+** or **-** buttons. To change something that is not flashing, press the **→** button until the desired field is flashing.

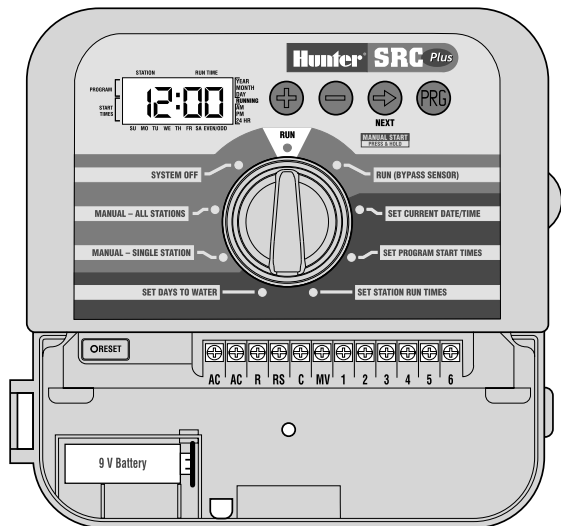

The SRC *Plus* also provides a reference label that is attached to the inside of the controller door (no more lost or misplaced instructions!). And, extra space is provided to write in sprinkler station location information.

A full three programs, each with the ability to have four daily start times, permit plants with different watering requirements to be separated on different day schedules. Multiple start times permit morning, afternoon, and evening watering, perfect for the establishment of new lawns and thirsty annual flowers. A built-in 365 day calendar clock accommodates odd/even watering restrictions without requiring monthly reprogramming. Or just simply designate the days of the week you want to water. The SRC *Plus* makes it easy.



NOTE: A basic programming rule is that whatever symbol or character is flashing will be the item programmed. For instance, if the hour is flashing when setting the time, the hour can be changed or programmed. For illustration purposes, flashing characters are in **GRAY** type.

To activate a program in your controller, you must enter the following information:

1. Set current day and time—turn dial to **SET CURRENT DATE/TIME**.
2. Set what time of day you would like the program to start—turn dial to **SET PROGRAM START TIMES**.
3. Set how long each valve will water—turn dial to **SET STATION RUN TIMES**.
4. Set the day(s) you would like the program to water—turn dial to **SET DAYS TO WATER**.



NOTE: All stations operate in numerical order. Only one program start time is required to activate a watering program.

PROGRAMMING THE CONTROLLER (continued)

Setting the Date and Time

- Turn the dial to the **SET CURRENT DATE/TIME** position.
- The current year will be flashing in the display: Use the **+** or **-** button to set the year. After setting the correct year, push the **➡** to proceed to setting the month.
- The month and day will be in the display: The month will be flashing. Use the **+** or **-** button to set the month. Push the **➡** to proceed to setting the day.
- The day will be flashing: Use the **+** or **-** button to set the day of the month. (The day of the week is automatically indicated by an arrow in the bottom of display pointing to the day.) Push the **➡** button to proceed to setting the time.
- The time will be displayed, and an arrow will be flashing on AM. Press the **+** or **-** buttons to select AM, PM, or 24 HR. Press the **➡** to proceed to setting the hours.

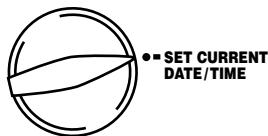

- Hours will be flashing. Press the **+** or **-** button to change the hour shown on the display. Press the **➡** to proceed to setting the minutes.
- Minutes will be flashing. Use the **+** or **-** button to change the minutes shown on the display. The date, day and time have now been set and the dial may be returned to the **RUN** position.



Setting Program Start Times

- Turn the dial to the **SET PROGRAM START TIMES** position.
- The factory preset is set on program **A**. If necessary, you can select program **B** or **C** by pressing the **PRG** button.
- Use the **+** or **-** button to change the start time. (The start times advance in 15 minute increments.) Hold either button down for 1 second to change times rapidly.
- Press the **➡** button to select the next start time, or press **PRG** for the next program.





NOTE: One start time will activate all stations sequentially in that program. This eliminates the need to enter each station's start time. Multiple start times in a program can be used for separate morning, afternoon, or evening watering cycles.

Eliminating a Program Start Time

With the dial set to the **SET PROGRAM START TIMES** position, push the **+** or **-** button until you reach 12:00 AM (Midnight). From here push the **-** button once to reach the **OFF** position.



NOTE: If a program has all four start times turned off, then that program is off. (All other program details are retained). Because there are no start times, there will be no watering with that program. This is a convenient way to stop watering on one program only without turning the dial to the **OFF** position.

Setting Station Run Times (Length of Watering for Each Area)

1. Turn the dial to the **SET STATION RUN TIMES** position.
2. The display will show the last program selected (**A**, **B**, or **C**) the station number selected, and the run time for that station will be flashing. You can switch to another program by pressing the **PRE** button.
3. Use the **+** or **-** button to change the station run time on the display.
4. Press the **➡** button to advance to the next station.
5. Repeat steps 3 and 4 for each station.
6. You can set station run times anywhere from 0 to 99 minutes.
7. You can move between programs while staying on the same station. However, it is recommended that one program is completed before going on to the next program.



SET STATION RUN TIMES



NOTE: Jumping between programs can be confusing and may result in program entry errors.

PROGRAMMING THE CONTROLLER (continued)

Setting Days To Water

1. Turn the dial to **SET DAYS TO WATER**.
2. The display will show the last program selected (**A**, **B**, or **C**). You can switch to another program by pressing the **PRG** button.
3. The controller will display currently programmed active day schedule information. This dial position provides different watering options: choose to water on specific days of the week, or choose to water only on odd days or even days. Each program can operate using only **one** type of water day option.

SET DAYS TO WATER

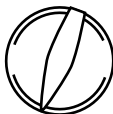

Selecting Odd or Even Days

This feature will use a numbered day of the month for watering instead of specific days of the week (Odd days 1st, 3rd, 5th, etc.; Even days 2nd, 4th, 6th, etc.)

1. Press the **+** button until the arrow cursor is above either **EVEN** or **ODD** on the display.
2. Press the **+** button to select or the **-** button to cancel either **Odd Days** or **Even Days**. The previous selected days of the week will revert to active if **Odd Days** or **Even Days** is cancelled.

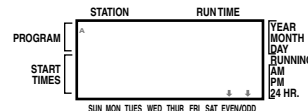

Selecting Specific Days of the Week to Water

1. With the arrow cursor on a specific day (the cursor always starts with Sunday), press the **+** button to activate a particular day of the week to water. Press the **-** button to cancel watering for that day. After pressing a button the cursor automatically advances to the next day.
2. Repeat step 1 until all desired days have been selected. The selected days arrows will show on the display to indicate their status as **ON**. The last solid arrow is the last day of watering for that program.

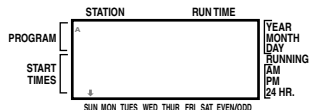

NOTE: The 31st of any month and February 29 are always "off" days if Odd watering is selected.

Run

After programming is complete, turn the dial to **RUN** to enable automatic execution of all selected programs and start times. **Watering will not occur unless dial is in the RUN or RUN (SENSOR BYPASS) position.**

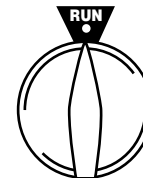

System Off

Valves currently watering will be shut off after the dial is turned to the **SYSTEM OFF** position for two seconds. All active programs are discontinued and watering is stopped. To return controller to normal automatic operation, simply return dial to **RUN** position.

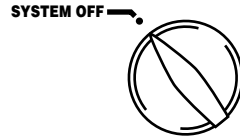

Manually Run a Single Station

1. Turn dial to the **MANUAL - SINGLE STATION** position.
2. Station run time will flash in the display. Use the \ominus button to move to the next station. You may use the \oplus or \ominus button to select the amount of time for a station to water.
3. Turn the dial clockwise to the **RUN** position to run the station (only the designated station will water, then the controller will return to automatic mode with no change in the previously set program).



Manually Run All Stations

1. Turn dial to **MANUAL-ALL STATIONS**.
2. You can select program **A**, **B**, or **C** by pressing the PROG button.
3. Press the \ominus button until desired starting station is displayed.
4. Station run time will flash in the display. Use the \oplus or \ominus buttons to select the amount of run time for the station to water.
5. Use the \ominus button to move to the next station.
6. Repeat steps 3 and 4 to customize each station.
7. Press the \ominus button until you reach the station that you would like watering to begin.
8. Return dial to **RUN** (custom program will water, then controller will return to automatic mode with no change in the previously set program).

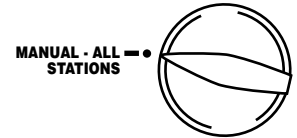

NOTE: The station that is on the display when you turn the dial to **RUN** will be the first station to run. The controller will then proceed to water in sequential order only. It will not water previous stations. Example: If you turn the dial to **RUN** with the display reading station 3. The controller will water stations 3 to 9 in the program, but not return to stations 1 and 2.

PROGRAMMING THE CONTROLLER (continued)

One Touch Manual Start and Advance

You can also activate all stations to water without using the dial.

1. Hold down the **▶** button for 2 seconds.
2. This feature automatically defaults to program A. You can select program B or C by pressing the **PRG** program.
3. The station number will be flashing. Press the **▶** button to scroll through the stations and use the **+** or **-** buttons to adjust the station run times. (If no buttons are pressed during step 2 or 3, the controller will automatically begin program A.)
4. Press the **▶** button to scroll to the station you wish to begin with. After a 2 second pause, the program will begin.

This feature is great for a quick cycle when extra watering is needed or if you would like to scroll through the stations to inspect your system.

Hunter Quick Check™

Irrigation professionals are continuously looking for ways to more efficiently and effectively diagnose programs in the field. Instead of having to physically check each field wiring circuit for potential problems, the user can run the Hunter Quick Check™ circuit test procedure. This circuit diagnostic procedure is very beneficial because of its ability to aid in quickly identifying "shorts" commonly caused by faulty solenoids or when a bare common wire touches a bare station control wire.

To initiate the Hunter Quick Check test procedure; Press the **+**, **-**, **▶**, and **PRG** buttons simultaneously. In the standby mode, the LCD will display all segments (helpful when troubleshooting display problems). Press the **+** button to begin the Quick Check test procedure. Within seconds, the system searches all stations in an effort to detect a high current path through the station terminals. When a field wiring short is detected, an ERR symbol preceded by the station number will momentarily flash on the controller LCD display. After the Hunter Quick Check completes running this circuit diagnostic procedure, the controller returns to the automatic watering mode.

Clearing the Controller's Memory/ Resetting the Controller

If you feel you have misprogrammed the controller, there is a process that will reset the memory to factory defaults and erase all programs and data that has been entered into the controller.

1. Press and hold down the **-**, **▶** and **PRG** buttons.
2. Press and release the reset button in the lower wiring compartment.
3. Release the **-**, **▶** and **PRG** buttons. The display should now show 12:00AM. All the memory has been cleared and the controller may now be reprogrammed.

TROUBLESHOOTING GUIDE

PROBLEM	CAUSES	SOLUTIONS
Controller waters the same area more than one time or cycles continuously.	Too many start times entered in program (user error).	One start time activates a complete cycle. See " Setting Program Times " (page 18).
The display reads "No AC"	There is no AC power present.	Check to make sure power is on. Check to see if transformer is properly installed.
Display indicates irrigation but station does not water.	Faulty or miswired valve	Check valve and valve wiring.
	Faulty pump or pump relay.	Check pump and pump relay. Replace if defective.
	No water pressure to supply.	Turn on main system water system.
Display is blank.	No AC power reaching controller.	Verify AC power and wiring. Correct any errors. Check transformer output.
Display is blank with AC power to terminal and with a new battery.	Controller may be damaged by power surge.	Call dealer.
Time of day display is blinking.	Unit has just been powered up for the first time.	Set time/date.
	Extended power outage has occurred that has drained backup battery.	Replace battery and reprogram current time.
	Short power outage has occurred but backup battery is dead.	Replace battery and reprogram current time.
The display reads "ERR".	Electrical noise is entering the system, through the smart port wiring harness.	Check the SmartPort® wiring harness. If the wires were extended then they will need to be replaced with shielded cable. Contact your local distributor for information on shielded cable.

TROUBLESHOOTING GUIDE (continued)

PROBLEM	CAUSES	SOLUTIONS
The display reads a station number and ERR	There has been a fault with the wire leading to the valve.	Check station wire for continuity. Replace or repair shorted wire. Check that all wire connections are good and watertight.
Rain Sensor does not suspend irrigation.	Rain sensor is defective or miswired.	Verify operation of sensor and proper wiring.
	Rain sensor is in the RUN (BYPASS SENSOR) position.	Return dial to the RUN position.
Frozen Display	Power surge.	Unplug transformer, remove battery, wait several seconds, repower and reprogram controller.
Automatic irrigation does not start at start time and controller is not in the system off mode.	AM/PM of time of day not set correctly.	Correct AM/PM of time of day.
	AM/PM of start time not set correctly.	Correct AM/PM of start time.
	Start time is disabled (Set for Off).	Set start time. See " Setting Start Times " (page 17).
	Rain sensor is preventing operation.	Turn dial to RUN (BYPASS SENSOR) .
	Controller is not receiving AC power.	Check AC connections.
Valve will not turn on.	Short in wire connections.	Check wiring for short or faulty wire connections.
	Bad solenoid	Replace solenoid.

SPECIFICATIONS

Operating Specifications

- Station Run Time: 0 to 99 minutes in 1-minute increments
- Start Times: 4 per day, per program, for up to 12 daily starts
- Watering Schedule: 7-day calendar or odd-even programming with 365-day clock/calendar

Electrical Specifications

- Transformer Input: 120VAC, 60Hz (230VAC, 50/60Hz International Use)
- Transformer Output: 26VAC, .75 amps
- Station Output: 24VAC, .35 amps per station
- Maximum Output: 24VAC, .75 amps (includes Master Valve Circuit)
- Battery Backup: 9-volt alkaline battery (not included)
- Three Programs: A, B, and C
- Non-Volatile Memory

Dimensions

- Overall Height: 8¼" (22 cm)
- Width: 8½" (21 cm)

FCC NOTICE.....

This controller generates radio frequency energy and may cause interference to radio and television reception. It has been type tested and found to comply with the limits for a Class B computing device in accordance with the specifications in Subpart J of Part 15 of FCC Rules, which are designed to provide reasonable protection against such interference in a residential installation. However, there is no guarantee that interference will not occur in a particular installation. If this equipment does cause interference to radio or television reception, which can be determined by turning the equipment off and on, the user is encouraged to try to correct the interference by one or more of the following measures:

- Reorient the receiving antenna
- Move the controller away from the receiver
- Plug the controller into a different outlet so that controller and receiver are on different branch circuits

If necessary, the user should consult the dealer or an experienced radio/television technician for additional suggestions. The user may find the following booklet prepared by the Federal Communications Commission helpful: "How to Identify and Resolve Radio-TV Interference Problems." This booklet is available from the U.S. Government Printing Office, Washington, D.C., Stock No. 004-000-00345-4 (price – \$2.00 postpaid).